



BRAM
Dosing Systems

Catalog 2018

**Laundry
Dosing System**



COMPANY PRESENTATION



BRAM s.r.l. nasce dall'esperienza di un gruppo di persone specializzate nel settore del dosaggio in generale. Obiettivo primario dei nostri sforzi è la Vostra soddisfazione, proponendo soluzioni innovative applicate alle Vostre specifiche esigenze.

Il nostro personale dinamico ed efficiente, sarà sempre a Vostra disposizione per qualunque tipo di aiuto nella risoluzione dei Vostri problemi e nell'adempimento delle Vostre richieste, in una politica aziendale incentrata principalmente sulla soddisfazione dei propri clienti e sul rafforzamento del desiderio di collaborazione ed assistenza, allo scopo di costruire un rapporto solido e duraturo con i nostri partner.



BRAM s.r.l. was born thanks to the experience of people specialized in dosing system.

Our main goal is our customer satisfaction, thus we meet with their specific needs using our innovative solutions. Our Technical department guarantees a high quality service, to solve any issue about products installation and maintenance and our efficient and dynamic staff is always available to help you with your needs and to fulfill your requests.

Our firm policy is to improve our skills and increase collaboration with our customers so to create a long term partnership.



BRAM s.r.l. erwächst aus die Erfahrung einer Gruppe von Experten in dem Bereich der Dosierung.

Unser Hauptziel ist Ihre Zufriedenheit, durch erneuende Lösungen für jede Bedürfnis.

Unser leistungsfähiges und dynamisches Personal ist immer zu Verfügung, um irgendwelches Problem zu lösen und um Ihre Verlangen nachzukommen.

Unsere Unternehmenspolitik strebt den Wunsch zu eine langzeitige Zusammenarbeit an, um eine stabile Beziehung mit unseren Partner zu bilden.



BRAM s.r.l. naît de l'expérience d'un groupe d'experts dans le secteur du dosage en général.

Votre satisfaction est l'objectif primaire des nosres efforts, avec solutions personnalisés pour vosres spécifiques exigences.

Notre personnel, compétent et dynamique, sera à Votre disposition pour résoudre tous vosres problèmes, et pour accomplir Vosres demandes, dans une politique d'entreprise qui se base sur la satisfaction des propres clients. Notre objectif est le désir de renforcer la collaboration et l'assistance, pour construire un rapport solide et durable avec nosres partenaires.



BRAM s.r.l. nace gracias a la experiencia de un grupo de personas especializadas en el sector de la dosificación.

Objetivo principal de nuestros esfuerzos es Su satisfacción, proponiendo soluciones innovativas sobrepuestas a Su específicas exigencias.

Nuestro personal dinámico y eficiente, será siempre a Su disposición por cualquier tipo de ayuda en la resolución de Su problemas y en el cumplimiento de Su solicitudes, en una política empresarial basada principalmente sobre la satisfacción de los mismos clientes y sobre la consolidación del deseo de colaboración y asistencia, con el objetivo de construir una relación sólida y duradera con nuestros partners.



- Establishment **BRAM s.r.l.**
- Introduction and developement a of dosing system for industrial dishwasher

2008



- Introduction and developement a of dosing systems for washing machine

2011



- Internationalization of the company

2013



- Introduction and developement a of dosing systems for swimming pool

2014



- New headquarters of 1550 mq

2016



- 10 Years in the market!

2018



GENERAL DIRECTOR
Andrea Ramacogi
a.ramacogi@bramitalia.com



CONTACT US

Info product
info@bramitalia.com

Accounting
amministrazione@bramitalia.com

Export Manager
f.rosignoli@bramitalia.com

Sales Italia
sales@bramitalia.com

Headquarter:
Via Malfatti75 - Rieti - Italy - Tel. 0039.0746.48.15.01



BRAM, THE ABILITY TO TURN AN IDEA INTO A PRODUCT!

SERIE PAN



BH



SP



SERIE PAN: Pompa singola pannellabile per lavanderia.
Motore 24 Vdc. Fornite senza Kit.



SERIE PAN: Single panelable laundry pump. 24 Vdc engine. Supplied without Kit



SERIE PAN: Pompe à linge à panneau unique. Moteur 24 Vcc. Livré sans kit



SERIE PAN: Bomba de lavandería monobloqueable. Motor de 24 Vdc. Suministrado sin Kit



SERIE PAN: Einflügelige Wäschepumpe. 24 Vdc Motor. Lieferung ohne Kit

MOD	LT/H	BAR	TUBE	mm
SP	14	0,1	Santoprene	7x13
SP	14	0,1	Silicone	6x12
BH20	50	0,1	Silicone	8x14
BH21	50	0,1	Santoprene	8x14
BH23	120	0,1	Santoprene	8x14
BH24	120	0,1	Silicone	8x14

KIT / OPTIONAL



7013



SEM9011



SEM9012



SEM9002



SEM8092



SEM9048



SEM9042



SEM8093

DIMENSIONS

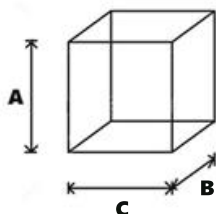

A: 140,0 mm
B: 75,0 mm
C: 115,0 mm
0,500 Kg

BH



SP

A: 100,0 mm
B: 50,0 mm
C: 70,0 mm
0,255 Kg



QR Code

SERIE BOX



BH

IP 56



PAV

IP 65



SC

IP 65



SERIE BOX: Pompe in cassa chiusa per lavanderia. Fornite senza Kit.



SERIE BOX: Pumps in a closed box for laundry. Supplied without Kit



SERIE BOX: Pompes dans une boîte fermée pour la lessive. Livré sans kit



SERIE BOX: Bombas caja serrada para lavandería. Suministrado sin Kit



SERIE BOX: Pumpen in einer geschlossenen Box für Wäsche. Lieferung ohne Kit

MOD	REG	LT/H	BAR	V	TUBE	mm
PAV6A000	Speed	14	0,1 bar	230 Vac	Santoprene	7x13
PAV5A000	Speed	14	0,1 bar	230 Vac	Silicone	6x12
SC13BK00	Fixed	14	0,1 bar	24 Vdc	Santoprene	7x13
SC14BK00	Fixed	14	0,1 bar	24 Vdc	Silicone	6x12
SC15BK00	Fixed	24	0,1 bar	230 Vac	Silicone	8x14
SC16BK00	Fixed	24	0,1 bar	230 Vac	Santoprene	8x14
BHC21SA	Fixed	50	0,1 bar	230 Vac	Santoprene	8x14
BHC20SI	Fixed	50	0,1 bar	230 Vac	Silicone	8x14
BHC24SA	Fixed	120	0,1 bar	230 Vac	Santoprene	8x14
BHC23SI	Fixed	120	0,1 bar	230 Vac	Silicone	8x14

KIT / OPTIONAL



SEM9011



SEM9012



7013



SEM8023



SEM9002



SEM8092



SEM9048



SEM9042



SEM8092

DIMENSIONS

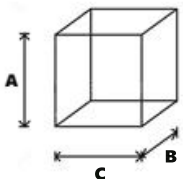

A: 140,0 mm
B: 75,0 mm
C: 115,0 mm
 0,500 Kg

BH



PAV



A: 145,0 mm
B: 105,0 mm
C: 80,0 mm
 0,405 Kg

SC



A: 120,0 mm
B: 95,0 mm
C: 70,0 mm
 0,380 Kg



QR Code



IP 65

DTL



SERIE DTL: Pompa singola **per lavanderia** con uscita segnali. Statistiche di attivazione, conteggio programmi, predisposizione sonda di livello, allarme e addescamento manuale.



SERIE DTL: Single pump **for laundry** with signal output. Activation statistics, program count, level probe preparation, alarm and manual priming.



SERIE DTL: Pompe simple **pour la lessive** avec sortie de signal. Statistiques d'activation, comptage de programme, préparation de sonde de niveau, alarme et amorçage manuel.



SERIE DTL: Bomba individual **para lavandería** con salida de señal. Estadísticas de activación, conteo de programa, preparación de sonda de nivel, alarma y cebado manual.



SERIE DTL: Einzelpumpe **für Wäsche** mit Signalausgang. Aktivierungsstatistiken, Programmzählung, Füllstandssondenvorbereitung, Alarm und manuelles Vorfüllen.

MOD	LT/H	BAR	TUBE	mm
DTLSA	14	0,1 bar	Satoprene	7x13
DTLSI	14	0,1 bar	Silicone	6x12

KIT / OPTIONAL



SEM9011

SEM9012

SEM8023

SEM9002

SEM9042

SEM9048

7013

DIMENSIONS

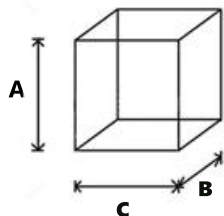

A: 145,0 mm
B: 105,0 mm
C: 80,0 mm
0,405 Kg

DTL

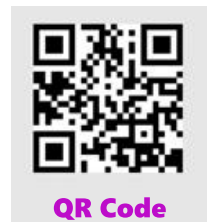

SERIE EASY FLY



EASY FLY

IP65



SERIE EASY FLY: Impianto specifico per **OPL** e **SELF SERVICE**.
Può lavorare in relè o con programmazione del segnale e delle pompe.
Programmazione tramite **DISPLAY FRONTALE**.
Possibilità di impostare il ritardo, il dosaggio e l'inibizione.
Funzione Autostart, ripristino programma e password.



SERIE EASY FLY: Specific plant for **OPL** and **SELF SERVICE**. It can work in relay or with signal and pump programming. Programming via **FRONT DISPLAY**. Ability to set delay, dosage and inhibition. Autostart function, program reset and password.



SERIE EASY FLY: Usine spécifique pour **OPL** et **SELF SERVICE**.
Il peut fonctionner en relais ou avec programmation de signal et de pompe. Programmation via **AFFICHAGE FRONTAL**. Possibilité de régler le délai, le dosage et l'inhibition. Fonction de démarrage automatique, réinitialisation du programme et mot de passe.



SERIE EASY FLY: Sistema específico para **OPL** y **SELF SERVICE**.
Puede funcionar en retransmisión o con programación de señal y bomba. Programación a través de la **PANTALLA DELANTERA**. Posibilidad de establecer el retraso, la dosis y la inhibición.
Función de inicio automático, reinicio del programa y contraseña.



SERIE EASY FLY: Spezifische Anlage für **OPL** und **SELF SERVICE**. Es kann in Relais- und Pumpenprogrammierung arbeiten. Programmierung über **FRONT DISPLAY**. Fähigkeit, Verzögerung, Dosierung und Hemmung einzustellen. Autostart Funktion, Programm Reset und Passwort.

MOD	LT/H	N° PUMPS		
		2	3	4
EASY FLY SF*	14			
EASY FLY	14			
9026**	Console (5 mt)	for set program		

* No Manifold
** Optional

KIT / OPTIONAL



SEM9011



SEM9012



2571



7013



SEM9042



SEM9048



SEM9002

DIMENSIONS

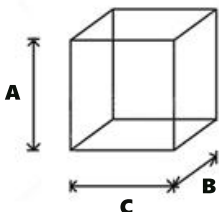

A: 220,0 mm
B: 135,0 mm
C: 300,0 mm
1,700 Kg

EASY FLY



QR Code

SERIE FLY SELF



FLY SELF

IP 65



SERIE FLY SELF: Specific plant for machines with programmable pump outputs. **Dosage in relay mode.** Delay start 15 sec, filter signal 5 sec, delay switch off 5 sec, delay switch off flux 20 sec.
From three to eight pumps that can be integrated into the system.
Flushing tube integrated into the standard system.



SERIE FLY SELF: Installation spécifique pour les machines à sorties de pompes programmables. **Dosage en mode relais.** Départ différé de 15 secondes, signal de filtrage de 5 secondes, temporisation désactivée de 5 secondes, temporisation de désactivation du flux de 20 secondes.
De trois à huit pompes pouvant être intégrées dans le système.
Tube de rinçage intégré dans le système standard.



SERIE FLY SELF: Sistema específico para máquinas con salidas de bomba programables. **Dosificación en modo relé.** Retardo de inicio 15 segundos, señal de filtro 5 segundos, retardo de desconexión 5 segundos, retraso de desconexión de flujo 20 seg.
De tres a ocho bombas que se pueden integrar en el sistema.
Tubo de enjuague integrado en el sistema estándar.



SERIE FLY SELF: Spezifische Anlage für Maschinen mit programmierbaren Pumpenausgängen. **Dosierung im Relaismodus.** Startverzögerung 15 Sek., Filtersignal 5 Sek., Verzögerung Ausschaltung 5 Sek., Verzögerung Ausschaltfluss 20 Sek. **Von drei bis acht Pumpen, die in das System integriert werden können.**
Spülrohr in das Standardsystem integriert.



SERIE FLY SELF: Impianto specifico per macchine con uscite pompe programmabili. **Dosaggio in modalità relè.** Ritardo partenza 15 sec, filtro segnale 5 sec, ritardo spegnimento segnale 5 sec, ritardo spegnimento flussaggio 20 sec.
Da tre a otto le pompe integrabili al sistema.
Tronchetto di flussaggio integrato al sistema standard.

MOD	LT/H	N° PUMPS					
		3	4	5	6	7	8
FLY SELF L- SF*	14						
FLY SELF L	14						
FLY SELF M	50						
FLY SELF H	120						

KIT / OPTIONAL



7013



SEM9011



SEM9012



2571



SEM9002



SEM8092



SEM8093



SEM9042



SEM9048

DIMENSIONS

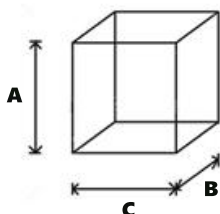

A: 220,0 mm
B: 135,0 mm
C: 300,0 mm
1,700 Kg

FLY SELF



QR Code

Single Box size = MOD L , MAX 4 pumps / MOD M/H, MAX 2 pumps.

SERIE FLY



SERIE FLY: Specific plant for not-evolved machines, **programmable thanks to PC software.** Selection console and fluxing box included in the standard version. Console that allows you to view and select programs, washing phase and system status. The FLY series has been designed to adapt to any type of washing machine.



SERIE FLY: Installation spécifique pour les machines non évoluées, **programmable grâce au logiciel PC.** Console de sélection et boîtier de flux inclus dans la version standard. Console qui vous permet d'afficher et de modifier les programmes, la phase de lavage et l'état du système. La série FLY a été conçue pour s'adapter à tout type de machine à laver.



SERIE FLY: Sistema específico para máquinas no evolucionadas, **programable gracias al software para PC.** Consola de selección y caja fundente incluida en la versión estándar. Consola que le permite ver y editar programas, fase de lavado y estado del sistema. La serie FLY ha sido diseñada para adaptarse a cualquier tipo de lavadora.



SERIE FLY: Spezifische Anlage für nicht entwickelte Maschinen, **programmierbar dank PC-Software.** Auswahlkonsole und Flussmittelbox in der Standardversion enthalten. Konsole, mit der Sie Programme, Waschphase und Systemstatus anzeigen und bearbeiten können. Die FLY-Serie wurde entwickelt, um sich an jede Art von Waschmaschine anzupassen.



IP 65



FLY



SERIE FLY: Impianto specifico per macchine non evolute, **programmabile grazie al software per PC.** Console di selezione e tronchetto di flussaggio incluso nella versione standard. Console che consente di visualizzare e modificare i programmi, la fase di lavaggio e lo stato del sistema. La serie FLY è stata progettata per adattarsi a qualsiasi tipo di lavabiancheria.

MOD	LT/H	N° PUMPS					
		3	4	5	6	7	8
FLY L- SF*	14						
FLY L	14						
FLY M	50						
FLY H	120						

KIT / OPTIONAL



7013



SEM9011



SEM9012



2571



SEM9002



SEM8092



SEM8093



SEM9042



SEM9048

DIMENSIONS

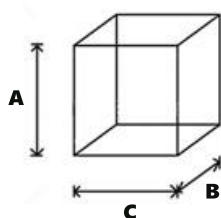

A: 220,0 mm
B: 135,0 mm
C: 300,0 mm
 1,700 Kg

FLY

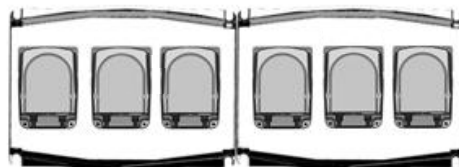

QR Code

Single Box size = MOD L , MAX 4 pumps / MOD M/H, MAX 2 pumps.



FLY SKID DLCE



SERIE FLY SKID DLCE: Impianto completo per lavabiancheria, installabile su qualsiasi tipo di macchina, particolarmente adatto per lavacontinue e grandi macchine.

Caratteristiche quadro: contenitore PRFV, portella trasparente o chiusa, pulsante di emergenza con auto-start, differenziale sull'interruttore generale e relè di scabio da 24 Vcc a 230 V.

Caratteristiche struttura: AISI 304, tubazioni in PVC e collegamenti elettrici inguainati.

Caratteristiche pompe: Membrana meccanica, motore trifase 230 V e materiali PP-AISI.

SERIE FLY SKID 550: Sistema di premiscelazione e dosaggio del detergente in polvere.

Serbatoio in PE, castello in INOX 304 + coperchio e aspirazione con valvola G.F. 1" 1/2.

SERIE FLY SKID BOX: Quadro per la gestione di sistemi di lavanderia dove sono applicate pompe di grandi portate e sistemi di scioglimento.



SERIE FLY SKID DLCE: Complete system for washing machines, installable on any type of machine, particularly suitable for washing machines and large machines.

Frame features: PRFV container, transparent or closed door, emergency button with auto-start, differential on the main switch and a 24 Vdc to 230 V scab relay.

Structure features: AISI 304, PVC pipes and sheathed electrical connections.

Pump characteristics: Mechanical diaphragm, 230 V three-phase motor and PP-AISI materials.



SERIE FLY SKID DLCE: Sistema completo para lavadoras, instalable en cualquier tipo de máquina, particularmente adecuado para lavadoras y máquinas grandes.

Características del cuadro: contenedor PRFV, puerta transparente o cerrada, botón de emergencia con autoarranque, diferencial en el interruptor principal y un relé scab de 24 Vdc a 230 V.

Características de la estructura: AISI 304, tuberías de PVC y conexiones eléctricas enfundadas.

Características de la bomba: diafragma mecánico, motor trifásico de 230 V y materiales PP-AISI.



SERIE FLY SKID DLCE: Système complet pour machines à laver, installable sur tout type de machine, particulièrement adapté pour les machines à laver et les grosses machines.

Caractéristiques du cadre: Conteneur PRFV, porte transparente ou fermée, bouton d'urgence avec démarrage automatique, différentiel sur l'interrupteur principal et un relais de protection contre la gale de 24 Vcc à 230 V.

Caractéristiques de structure: AISI 304, tuyaux en PVC et connexions électriques gainées.

Caractéristiques de la pompe: diaphragme mécanique, moteur triphasé 230 V et matériaux PP-AISI.



SERIE FLY SKID DLCE: Komplettes System für Waschmaschinen, installierbar auf jeder Art von Maschine, besonders geeignet für Waschmaschinen und große Maschinen.

Rahmenmerkmale: PRFV-Container, transparente oder geschlossene Tür, Not-Aus-Taster mit Autostart, Differential am Hauptschalter und ein 24 VDC bis 230 V Schorfrelais.

Strukturmerkmale: AISI 304, PVC-Rohre und ummantelte elektrische Verbindungen.

Pumpenkennlinie: Mechanische Membrane, 230 V Drehstrommotor und PP-AISI-Werkstoffe.

MOD	N°PUMPS	≤ 150 kg ≤ 150 l/t	> 150 kg > 150 l/t
FSKIDLCE4	4		
FSKIDLCE5	5		
FSKIDLCE6	6		



QR Code



FLY SKID 550



SERIE FLY SKID 550: Sistema di premiscelazione e dosaggio del detergente in polvere. Serbatoio in PE, castello in INOX 304 + coperchio e aspirazione con valvola G.F. 1" 1/2.

Optional:

1. Carico acqua automatico con contatore ed elettrovalvole.
2. Agitatore con riduttore ed albero INOX 304
3. Supporto rinforzato PP
4. Quadro elettrico con gestione del comando agitatore, del livello (H2O / sec) e pompe di dosaggio (standard 3 pompe).
5. Pompa centrifuga completa di valvola di non ritorno.

*Si personalizzano i skid su richiesta.



SERIE FLY SKID 550: Powder premixing and dosage system of the detergent. PE tank, 304 stainless steel castle + cover and intake with G.F. 1" 1/2.

Optional:

1. Automatic water load with counter and solenoid valves.
2. Agitator with reducer and stainless steel shaft 304
3. PP reinforced support
4. Electrical panel with agitator control, level (H2O / sec) and dosing pumps (standard 3 pumps).
5. Centrifugal pump complete with non-return valve.

* Skid on request is customized.



SERIE FLY SKID 550: Pré-mélange de poudre et système de dosage du détergent. Réservoir en PE, château en acier inoxydable 304 + couvercle et prise d'air avec G.F. 1" 1/2.

En option:

1. Charge d'eau automatique avec compteur et électrovannes.
2. Agitateur avec réducteur et arbre en acier inoxydable 304
3. Support renforcé PP
4. Panneau électrique avec commande d'agitateur, niveau (H2O / sec) et pompes doseuses (3 pompes standard).
5. Pompe centrifuge complète avec clapet anti-retour.

* Skid sur demande est personnalisé.



SERIE FLY SKID 550: Sistema de premezcla y dosificación de polvo del detergente. Depósito de PE, 304 de acero inoxidable castle + cover y admisión con G.F. 1" 1/2.

Opcional:

1. Carga de agua automática con contador y válvulas solenoides.
2. Agitador con reductor y eje de acero inoxidable 304
3. Soporte reforzado PP
4. Panel eléctrico con control del agitador, nivel (H2O / seg) y bombas de dosificación (bombas estándar 3).
5. Bomba centrifuga completa con válvula de retención.

* Skid bajo pedido es personalizado.



SERIE FLY SKID 550: Pulvervormischung und Dosiersystem des Waschmittels. PE-Tank, 304 Edelstahl Burg + Deckel und Aufnahme mit G.F. 1 1/2.

Optional:

1. Automatische Wasserbefüllung mit Zähler- und Magnetventilen.
2. Rührwerk mit Reduzierstück und Edelstahlwelle 304
3. PP verstärkte Unterstützung
4. Schalttafel mit Rührwerksteuerung, Füllstand (H2O / Sek.) Und Dosierpumpen (Standard 3 Pumpen).
5. Kreiselpumpe mit Rückschlagventil.

* Skid auf Anfrage ist angepasst.

MOD	DES
SKID550	SKID 550 l/t
QESKID	Electronics for automatization

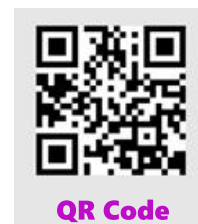

QR Code



BMB



BMB: Pompa dosatrici elettromeccaniche a membrana con ritorno a molla. Cassa in alluminio. Regolazione della membrana tramite nonio graduato di fine corsa, 0-100%.



BMB: Electromechanical diaphragm metering pump with spring return. Aluminum case. Adjustment of the membrane with graduated vernier at the end of stroke, 0-100%.



BMB: Pompe doseuse à membrane électromécanique à rappel par ressort. Boîtier en aluminium. Ajustement de la membrane avec vernier gradué en fin de course, 0-100%.



BMB: Bomba dosificadora de membrana electromecánica con retorno de muelle. Caja de aluminio. Ajuste de la membrana con pomo graduado al final de la carrera, 0-100%.



BMB: Elektromechanische Membrandosierpumpe mit Federrückstellung. Aluminiumgehäuse. Einstellung der Membran mit abgestuftem Nonius am Hubende, 0-100%.

MOD	LT/H	BAR	STROKES	KW	CONNECTION		CONNECTION (FLANGE)		P	A
					P	A	P	A		
BMB 101	101	6	95	0,2	3/8 G.F.	3/8 G.F.	DN15- 1/2 ANSI 150	DN15- 1/2 ANSI 151		
BMB 155	155	6	155	0,2	3/8 G.F.	1/2 G.F.	DN15- 1/2 ANSI 150	DN15- 1/2 ANSI 151		
BMB 261	260	7	95	0,3	3/4 G.F.	3/4 G.F.	DN20- 3/4 ANSI 150	DN20- 3/4 ANSI 151		
BMB 321	320	5	115	0,3	1 G.F.	1 G.F.	DN25- 1 ANSI 150	DN25- 1 ANSI 151		
BMB 421	420	5	155	0,3	1 G.F.	1 G.F.	DN25- 1 ANSI 150	DN25- 1 ANSI 151		

ELEMENTS	MATERIALS			
	A	P	PA	P32
HEAD	AISI-316 L	AISI-316 L	PVC	AISI-316 L
MEMBRANE	PTFE	PTFE	PTFE	PTFE
VALVE SEAT	PP	PP	PP	PP
VALVE GUIDE	AISI-316 L	PVC	AISI-316 L	INCOLORY-825
VALVE	AISI-316 L	PIREX	AISI-316 L	HASTELLOY C-276
VALVE HOLD	FPM	FPM	FPM	FPM
CONTAINER	PP	PP	PP	PP
FLANGE	AISI-316 L	PVC	PVC	PVC
FLANGED CONTAINER	AISI-316 L	PVC	PVC	PVC

*For AC and PA model contact sales office



QR Code



SPARE PARTS

	COD	DES	
	1009G	Ball Bearing	
	SEM9002	Bottom valve	
	4043	Cable Console 10 mt (4x0,22)	
	4043	Cable Console 25 mt	
	CV112	Cable Signal 20 mt (12x0,22)	
	4065	Circuit Adapter SD - USB	
	RS 75-24	Circuit Power Supply 260 Vac	
	4088	Circuit CPU FULL	
	4088-S	Circuit CPU SELF	
	4077	Circuit DTL	
	4004	Circuit PV	
	4089	Circuit PAV	
	SEM 9008	Collector 3 pumps	
	SEM 9005	Collector 4 pumps	
	SEM 9006	Collector 5 pumps	
	SEM 9007	Collector 6 pumps	
	SEM 9073	Collector 7 pumps	
	SEM 9074	Collector 8 pumps	
	SEM9000	Collector Valve	
	SEM8027	Complete port holder for pump 24 lt	
	SEM8025	Complete port holder for pumps up to 15 l / h	
	SEM9024	Complete port holder for HP pump	
	SEM9027	Complete port holder for EPX BRILL pumps	
	SEM 9013	Console with cable 5 mt	
	2601	Cover DE	
	SEM8015	Cover DTL	
	SEM8015xxx	Cover customized DTL	
	SEM8112	Cover SP	
	SEM8112xxx	Cover Customized SP	
	SEM9024	Front Cover BH pump	
	4046	Flow sensor	
	YW_203	Green Lamp	
	2608	Mounting brecket	
	P9104	Polycarbonate Console	

SPARE PARTS

	P9100	Polycarbonate DTL ex PTL DM	
	P9176	Polycarbonate EASY FLY 2	
	P9179	Polycarbonate FLY / FLY SELF	
	SEM 9014	Replacement pump mod L (including wiring)	
	SEM 9015	Replacement pump mod M (including wiring)	
	SEM 9016	Replacement pump mod H (including wiring)	
	9061	SD Card	
	8001	Software Fly su CD / USB	
	2571	Washing Machine Tube 3 mt	
	YW1-201	Rectangular toggle switch with cover	
	3028	Motor 24Vcc - 350 rpm	
	3012	Motor 24Vcc - 160 rpm	
	3004	Motor 24Vcc - 95 rpm	
        	7014SR	Santoprene 6x10 peristaltic tube without fitting and ring nut	
	SEM8065	Santoprene 6x10 peristaltic hose with GP compatible fittings	
	7018SR	Santoprene 8x14 L-M-H without compatible fittings	
	SEM8062	Santoprene 8x14 peristaltic hose with L compatible fittings	
	SEM8092	Santoprene 8x14 peristaltic for M / H pump	
	SEM9003	Santoprene peristaltic tube 9x16 with compatible fittings	
	7017SR	Santoprene peristaltic tube 9x16 without compatible fittings	
	SEM9039	Santoprene peristaltic tube 8x14; L= 29 cm, with fittings	
	7014RSR	Santoprene peristaltic tube 7x13 without fittings	
	SEM9042	Peristaltic BS 7*13 with fittings	
         	SEM8064	Silicone peristaltic tube 6x10 with with GP compatible fittings	
	7012SR	Silicone peristaltic tube 6x10 without fittings	
	SEM9048	Silicone peristaltic tube 6*12 with fittings 6x12	
	7025SR	Silicone peristaltic tube 6*12 without fittings	
	SEM8063	Silicone peristaltic tube 8*14 with compatible fittings	
	SEM 8093	Silicone peristaltic tube 8*14 H pumps	
	7015SR	Silicone peristaltic tube 8*14 without compatible fittings	
	SEM 9038	Silicone peristaltic tube 8*14 ; L=29 cm, with fittings	
	SEM 9040	Silicone peristaltic tube 9*16; L= 29 cm, with fittings	
	SEM 9004	Silicone peristaltic tube 9*16; with compatible fittings	
	9056	Solenoid valve 24 Vdc	
   	SEM 9028	Suction lance without valves 50 cm	
	SEM 9025	Suction launches with valve 50 cm	
	SEM 9012	Suction lance pvc level 50 cm	
	SEM 9011	Suction lance pvc - sil 50 cm	

SPARE PARTS

	O206	Tap 3/4 F-M-M	
	7013	Tube PVC 8x12 50 mt	
	SEM8019	Tube PVC 8x12 5 mt	

BOX

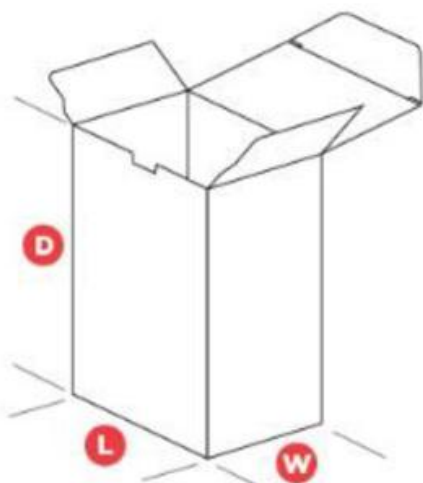
9003	Box Single pump: L 180 x W 120 x D 120 h Medium Weight mod. DTL: 0,65 kg	
9017	Box EASY FLY / FLY / SELF up to 4 pumps L – L 430 x W 330 x D 230 h – Medium Weight 7,5 kg	
9096	Multiple Box 24 / Accessories: L 570 x W 530 x D 280 Medium Weight: DTL: 16 kg	
9100	Fly Box EASY FLY / FLY / SELF up to 4 pumps L + Accessories: - Old Gewiss Box L 510 x W 400 x D 200 h Medium Weight: 10 Kg	
9101	EASY FLY / FLY / SELF L 5 – 8 pumps - FLY / SELF M/H up to 4 pumps: L 810x W270 x D 360 h Medium Weight: 15 Kg with accessories 20 Kg	
NOTICE	For FLY/ SELF M/H 5-8 pumps – the box will be customized.	



BRAM s.r.l. Via F.M. Malfatti, 75 - 02100 Rieti - Italy
T: +39 0746481501
info@bramitalia.com - www.bram-group.com

The technical data may be altered without prior warning. The images are for illustrative purpose only. BRAM s.r.l. / Design and printed in Italy/

